

B-4 for imc ARGUSfit

4-channel measurement module for strain gauge, bridge mode and voltage



The B-4 module belonging to the imc ARGUSfit series is a 4-channel measurement amplifier that can be used in conjunction with an imc ARGUS system (or base unit) to which it is directly docked with its housing.

Individually isolated, configurable differential channels capturing:

- Strain gauges, bridge-mode sensors and potentiometers
- Voltages (25 mV to 10 V)
- Active transducers that require voltage supply

Highlights

- Per-channel isolated measurement inputs, individual filtering and ADCs
- Software selectable quarter-bridge completion with 120 Ω , 350 Ω und 1 k Ω
- Bridge and sensor supply, channel-wise individually configurable
- Bridge mode excitation from 5 V down to 0.5 V
- Sensor supply of voltage-fed transducers up to +15 V
- 40 kHz bandwidth at max. 100 kSps/channel sampling rate
- Graphical configuration wizard to setup strain gauge modes
- Measurement ranges and sampling rates individually selectable (in steps of 1, 2, 5)
- 24-bit digitization, internal processing and data output
- Robust, compact and miniaturized: click mechanism for imc ARGUSfit systems

Typical applications

- Robust data acquisition for mobile or stationary applications and for test benches
- Strain gauge, load cells, piezoresistive accelerometers, potentiometer transducers, pressure sensors
- Durability and fatigue analysis
- Active voltage-fed sensors

imc ARGUSfit: Flexible modular platform for fast measurement systems

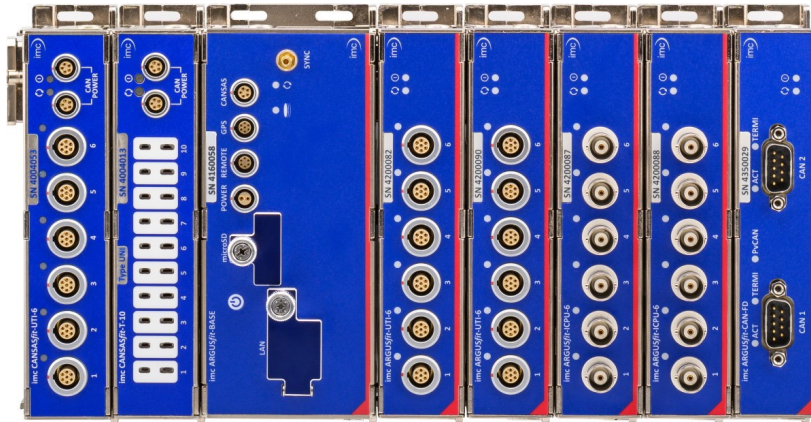

Based on an imc ARGUSfit base unit, imc ARGUSfit measurement amplifier and interface modules can be combined to form complete systems by means of a robust click mechanism, which can even integrate imc CANSASfit modules. The click connectors provide the electrical connection to the power supply and system bus.

For expansion to decentralized distributed topologies, the fast internal ARGFT system bus can be converted to fiber optic cables by means of a clickable fiber converter module.

The entire system can be controlled via a common Ethernet connection (LAN/WLAN) with a PC (imc STUDIO software) and can be networked and operated synchronously and uniformly with all other imc data acquisition instrument series. Furthermore, it can also be operated autonomously and stand-alone without PC with data storage on microSD.

Dimensions

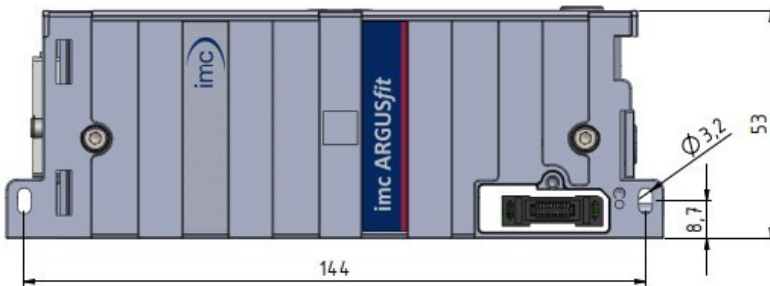

imc ARGUSfit B-4

Module shown in standard operating position (terminal connections upwards)

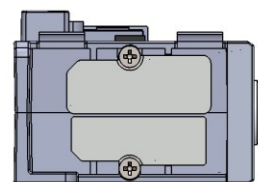
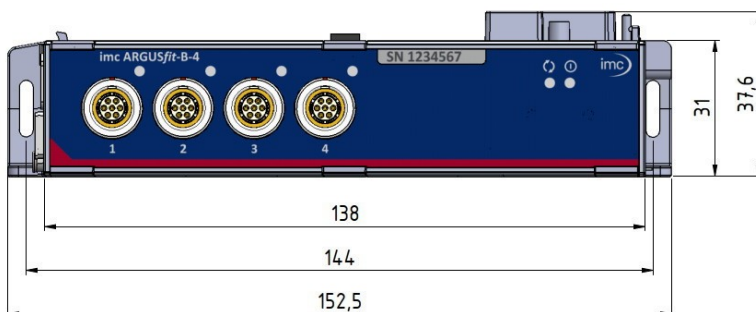

left module panel with parking position for the covers of the module connectors

Overview of the available variants

Order Code	Properties	article no.
ARGFT/B-4	strain gauge (bridge) amplifier with sensor supply (-40°C... +85°C)	11400214
ARGFT/B-4-EC	variant for extended condensation	11410204

Included accessories

Documents
Getting started with imc ARGUSfit (one copy per delivery)
Device certificate
Miscellaneous
4x ACC/CAP-LEMO.1B, 13500233 (protective cover for LEMO.1B sockets)

Optional accessories

Connector: signals		
ACC/FGG.1B.307-5.3-6.2	plug for the signal connection (FGG series, IP50)	13500096
ACC/FEG.1B.307-3.1-4.2	plug for the signal connection (FEG series, IP54)	13500262
ACC/FGG.1B.307-TERMINAL	screw terminal plug LEMO.1B, 7 pin (FGG series) LEMO plug with integrated screw terminal adaptor (7 pin + shield)	13500418
Fiber-Converter Set		
ARGFT/FIBER-CONVERTER-SET	Media converter for the ARGUS system bus Includes: 2 converter modules, 2x SFP+ transceiver, 5 m fiber optic cable, AC/DC power adaptor and a power plug	11400225
Mounting accessories		
CANFT/BRACKET-DIN	Mounting on DIN-Rail (top hat rail) for imc ARGUSfit and imc CANSASfit	12100029
CANFT/BRACKET-MAG	Mounting with magnet system for imc ARGUSfit and imc CANSASfit	12100030
Documents		
SERV/CAL-PROT	Calibration protocol per amplifier imc manufacturer calibration certificate with measurement values and list of calibration equipment used (pdf).	150000566
SERV/CAL-PROT-PAPER	Calibration protocol per amplifier (paper print) imc manufacturer calibration certificate with measurement values and list of calibration equipment used with signature and seal.	150000578

Device certificates and calibration protocols: Detailed information on certificates supplied, the specific contents, underlying standards (e.g. ISO 9001 / ISO 17025) and available media (pdf etc.) can be found on our website, or you can contact us directly.

Technical Specs - ARGFT/B-4

General

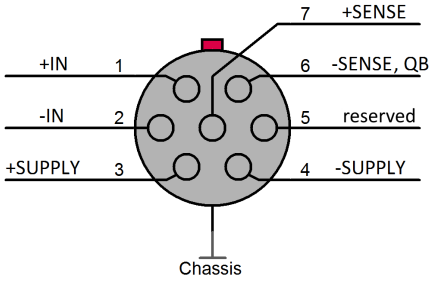

Inputs, measurement modes		
Parameter	Value	Remarks
Inputs	4	
Measurement modes	voltage full-, half- and quarter bridge	with internal half- and quarter bridge completion
Connector / socket Measuring input LEMO pin configuration	compatible socket LEMO.1B.307 (7-pin)	recommended plug FEG.1B.307
Module connector	 <p>Click-connection (covering caps)</p>	For the supply and system bus of directly connected modules without further cables, see data sheet of ARGFT base unit.

Sampling rate, Bandwidth, Filter			
Parameter	Value typ.	min. / max.	Remarks
Sampling rate		≤100 kHz	configurable, individually per channel
Bandwidth	0 Hz to 40 kHz 0 Hz to 20 kHz		sampling rate 100 kHz, AAF filter -3 dB 0.1 dB
Filter			
Type	low pass		
Characteristic	Mean, Butterworth, Bessel, AAF		individual selectable; mean and AAF: adapted automatically, according to selected output rate
Cut-off frequency	1 Hz to 20 kHz		-3 dB, 1 - 2 - 5 steps digital filter in addition to hardware filter
Order	8 th order		
Anti-Aliasing Filter (AAF)	Cauer 8 th order		with $f_{\text{cut-off}} = 0.4 f_s$; f_s : output rate
Resolution	24 Bit		data output: 32 Bit Float (24 Bit mantissa)

Isolation		
Parameter	Value	Remarks
Isolation	galvanically isolated	
channel-to-case (CHASSIS)	±60 V	test voltage: ±300 V (10 s)
channel to power supply	±60 V	test voltage: ±300 V (10 s)
channel-to-channel	±60 V	test voltage: ±300 V (10 s)

Power supply of the module			
Parameter	Value typ.	min. / max.	Remarks
Input supply voltage		7 V to 50 V DC 9.5 V to 50 V DC	operating upon power up power supply via base unit, fiber converter or UPS module
Power consumption	2 W @ 12 V 3 W @ 12 V	<7 W	sensor supply not loaded sensor supply loaded
Isolation		±60 V	to case (CHASSIS), isolation impedance ≥1 MΩ

Pass through power limits for directly connected modules (click-mechanism)		
Parameter	Value	Remarks
Max. current	5 A	at 85 °C current rating of click connector to ARGFT modules
	60 W at 12 V DC 120 W at 24 V DC	typ. DC vehicle voltage AC/DC power adaptor and installations

LED		
Parameter	Value	Remarks
Power-LED  green	power active	
Status-LED  green blue magenta yellow red	multicolor operating, run init, etc. firmware update prepare configuration error	global status of module
Channel-Status-LED off green red	bicolor channel passive channel active over-range error	status for each channel >5% over nominal range

Sensor supply			
Parameter	Value typ.	min. / max.	Remarks
Output voltage	15 V, 12 V, 10 V, 7,5 V, 5 V, 4 V, 3.5 V, 3.3 V, 3 V, 2.5 V		referenced to -SUPPLY, arbitrary for each channel
Short-Circuit-Proof		unlimited time	protection for module and each channel
Error of output voltage		±3% 0.01%/K·ΔT _a	ΔT _a = T _a - 25°C , with T _a = ambient temperature
Max. output current	150 mA		
Output power per channel		0.5 W	depending on output current limit
Capacitive load	0 to 1000 μF		
Output impedance	0.5 Ω		

Measurement modes

Voltage measurement			
Parameter	Value typ.	min. / max.	Remarks
Input ranges	±10 V, ±5 V, ±2.5 V, ±1 V to ±25 mV		
Max. over voltage		±60 V	
Input coupling		DC	
Input impedance	1 GΩ		
Gain error		0.02% + 0.001%/K·ΔT _a	of the measured value ΔT _a = T _a - 25°C , with T _a = ambient temperature
Offset error		0.02% or 10 μV + 0.001%/K·ΔT _a	of input range whichever is greater ΔT _a = T _a - 25°C , with T _a = ambient temperature
Nonlinearity	6 ppm		
Isolation mode rejection ratio (IMRR)	120 dB		50 Hz
Signal-to-Noise Ratio (SNR)	107 dB 107 dB 107 dB 105 dB 104 dB 103 dB 98 dB 93 dB 87 dB		bandwidth = 1 kHz; input ranges: 10 V 5 V 2.5 V 1 V 500 mV 250 mV 100 mV 50 mV 25 mV

Bridge measurement			
Parameter	Value typ.	min. / max.	Remarks
Input ranges	±1000 mV/V, ±500 mV/V, ±250 mV/V,..., ±500 mV/V, ±250 mV/V, ±100 mV/V,..., ±25 mV/V,..., ±2.5 mV/V ±5 mV/V ±10 mV/V ±25 mV/V		full bridge half bridge quarter bridge for excitation voltage ($V_{\text{excitation}}$): 5 V 2.5 V 1 V 0.5 V
Max. over voltage		±60 V	
Input coupling		DC	
Input impedance ±IN ±SENSE	1 GΩ 10 MΩ		
Gain error		0.03% + 0.05% + 0.05% + 0.001%/K·ΔT _a	of the measured value full and half bridge input ranges ≥ 5 mV/V input range = 2.5 mV/V quarter bridge, all ranges ΔT _a = T _a - 25°C , with T _a = ambient temperature
Offset error ¹		0.03% + ± 7 μV/V/K·ΔT _a 0.03% + ± 0.4 μV/V/K·ΔT _a 0.05% + ± 0.1 μV/V/K·ΔT _a	full and half bridge, of input range 1000 mV/V, ..., 100 mV/V 50 mV/V, ..., 10 mV/V 5 mV/V, ..., 2.5 mV/V ΔT _a = T _a - 25°C , with T _a = ambient temperature
Nonlinearity	6 ppm		

¹ After a bridge balancing process, the offset is nearly zero.

Bridge measurement			
Parameter	Value typ.	min. / max.	Remarks
Excitation voltage	5 V, 2.5 V, 1 V, 0.5 V	±0.05%	This tolerance must not be added when calculating total uncertainty. It is fully compensated due to the factory adjustment.
Load regulation range (Compensation of cable resistance by using ±SENSE)	90% to 100%		of excitation voltage $R_{\text{bridge}} / (R_{\text{bridge}} + R_{\text{cable}})$
Load regulation	-0.07 ppm/Ω·R _{cable}		additional gain error: compensation of cable resistance by using ±SENSE-inputs
Bridge resistance	100 Ω to 10 kΩ		
Half bridge completion		0.0005%/K·ΔT _a	ΔT _a = T _a - 25°C , with T _a = ambient temperature
Quarter bridge completion	1 kΩ, 350 Ω, 120 Ω	±0.1% +	This tolerance must not be added when calculating total uncertainty. It is fully compensated due to the factory adjustment as well as the bridge balancing process.
Drift		0.0005%/K·ΔT _a	ΔT _a = T _a - 25°C , with T _a = ambient temperature
Shunt calibration resistors (integrity check for entire signal chain)	499.5 kΩ, 174.83 kΩ, 59.94 kΩ	±0.12%	R _{bridge} : 1 kΩ 350 Ω 120 Ω
Isolation mode rejection ratio (IMRR)	150 dB		50 Hz, full bridge
Signal-to-Noise Ratio (SNR) ²	107 dB 107 dB 106 dB 104 dB 103 dB 99 dB 92 dB 87 dB 81 dB		bandwidth = 1 kHz, V _{excitation} = 5 V, full bridge, 120 Ω, input ranges: ±1000 mV/V ±500 mV/V ±250 mV/V ±100 mV/V ±50 mV/V ±25 mV/V ±10 mV/V ±5 mV/V ±2.5 mV/V

2 Add a value of 20 dB · log (V_{excitation}/5 V) for bridge excitation voltages different to 5 V.

Operating conditions

Operating conditions		
Parameter	Value	Remarks
Operating environment	dry, non corrosive environment within specified operating temperature range	
Ingress protection class	IP50	with correctly mounted covers over both module connectors
Pollution degree	2	
Operating temperature range	-40 °C to +85 °C	standard version: without condensation "-EC" version: temporary condensation allowed
Shock- and vibration resistance	IEC 60068-2, IEC 61373 IEC 60062-2-64 category 1, class A and B MIL-STD-810 Rail Cargo Vibration Exposure U.S. Highway Truck Vibration Exposure	
Extended shock- and vibration resistance	upon request	specific tests or certification upon request
Dimensions (L x W x H)	approx. 153 x 40 x 54 mm	including mounting flanges and click mechanism, see mechanical drawings 
Weight	0.33 kg	



An Axiometrix Solutions Brand

Contact imc

Address

imc Test & Measurement GmbH
Voltastr. 5
13355 Berlin

Phone: (Germany): +49 30 467090-0

E-Mail: info@imc-tm.de

Internet: <https://www.imc-tm.com>

Tech support

If you have problems or questions, please contact our tech support:

Phone: (Germany): +49 30 467090-26

E-Mail: hotline@imc-tm.de

Internet: <https://www.imc-tm.com/service-training/>

imc ACADEMY - Training center

The safe handling of measurement devices requires a good knowledge of the system. At our training center, experienced specialists are here to share their knowledge.

E-Mail: schulung@imc-tm.de

Internet: <https://www.imc-tm.com/service-training/imc-academy>

International partners

You will find the contact person responsible for you in our overview list of imc partners:

Internet: <https://www.imc-tm.com/imc-worldwide/>

imc @ Social Media

<https://www.facebook.com/imcTestMeasurement>

<https://www.youtube.com/c/imcTestMeasurementGmbH>

https://twitter.com/imc_de

<https://www.linkedin.com/company/imc-test-&-measurement-gmbh>